

iTRONIC

Installation Manual

BMW S58 G8X

M3/M4



Installation manual for BMW models:

- G8X M3
- G8X M4

Important note:

Premium Fuel (Octane 98 or higher*) is highly recommended for increased performance and reliability!

**Octane 93 or higher in Brazil, Canada, and The United States*

Content of the Box

- iTronic engine controller
- iTronic wiring harness
- Installation hardware



Before starting the installation of this product, please read this installation manual carefully to prevent possible damage or injuries.

Table of Contents

1. Preparing for installation	3
2. Overview	4
3. Installation	6
4. Using the iTronic	20

1 *Preparing for Installation*

1. Tools recommended for installation:
 - Screwdriver set
 - Socket set (10, 13, and 15 mm)
 - T50 torx
 - 5mm hex key
2. Find a suitable place for installation, preferably inside, to prevent the open connectors from getting wet.
3. Prepare an empty space to place the parts that you temporarily have to remove from your engine bay, like the engine cover or other parts. This helps you after installation to easily check if all the removed parts are installed back into the engine bay.
4. Do not make any changes or modifications to the iTronic Module, including changing the length of the wiring harness.
5. Open the hood, make sure the ignition is switched off, then remove the key and close the doors. Now wait 5 minutes before starting the installation, so the car has gone into sleep mode.

2.1 *Overview*

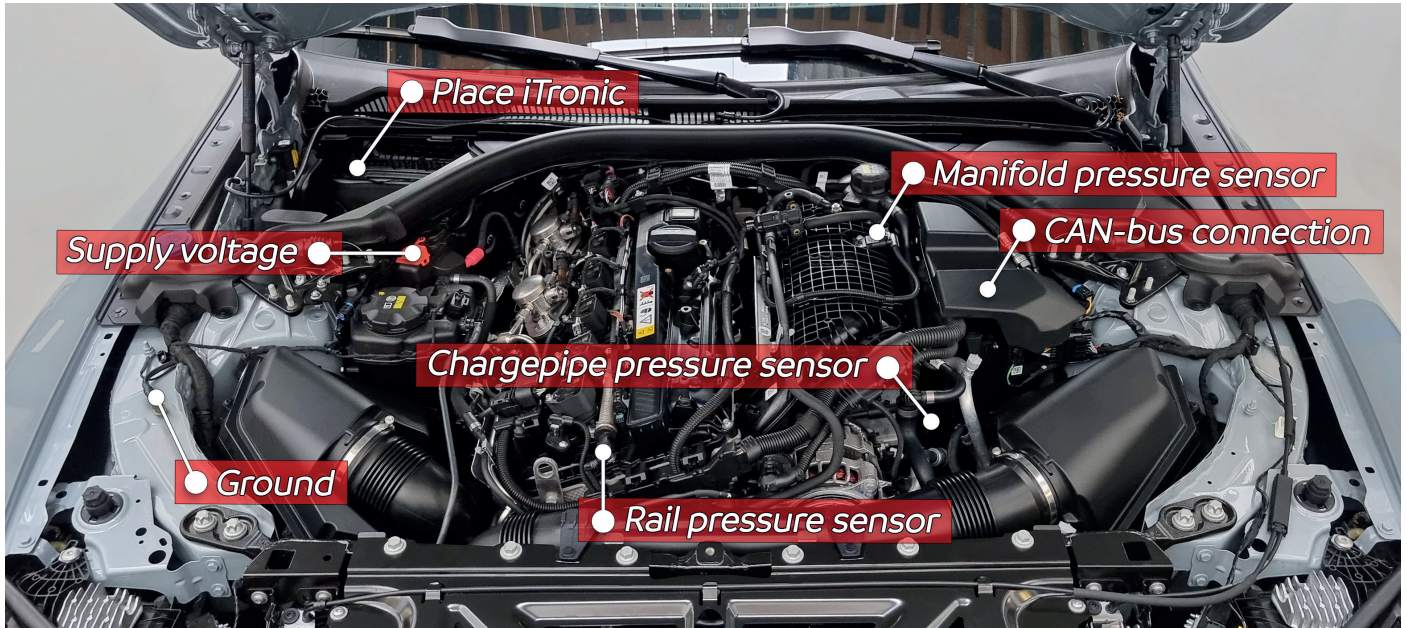

2.2

Wiring harness route

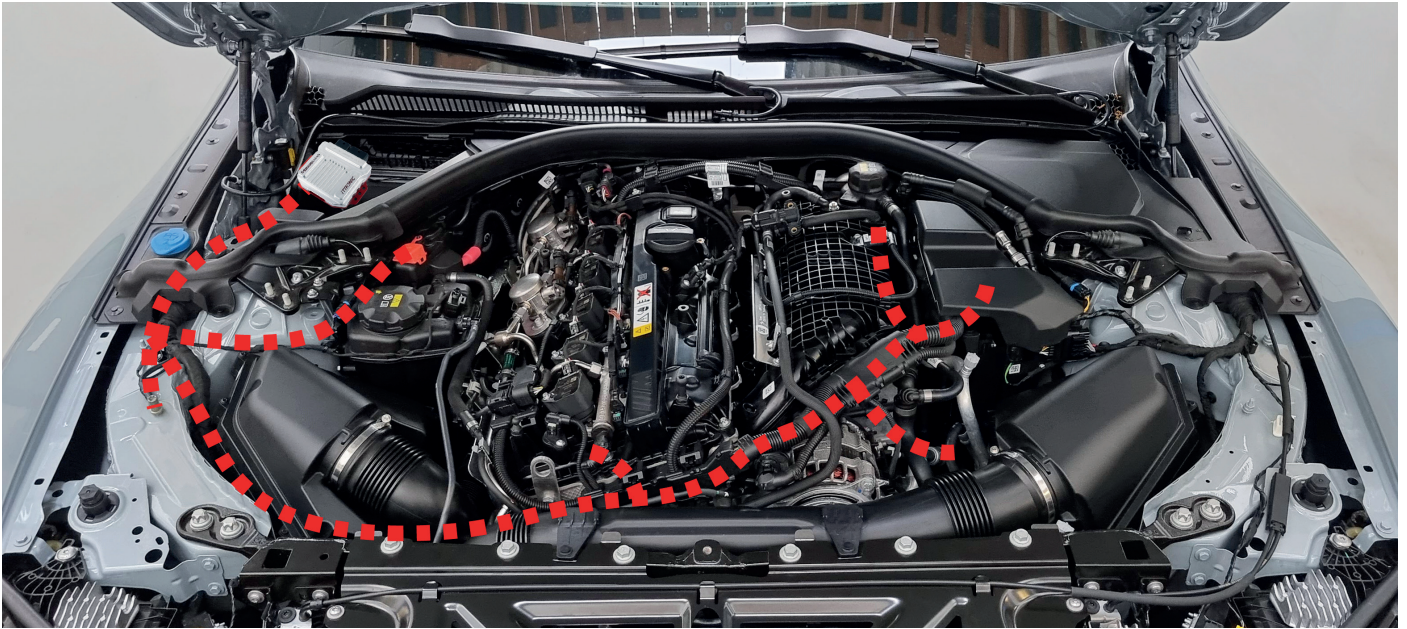

3

Installation

3.1 Remove the windshield cover.

- Remove the windshield cover located in fig. 1.1.

No tools are needed for this action.

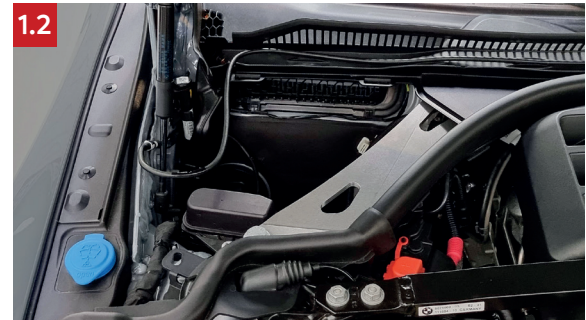
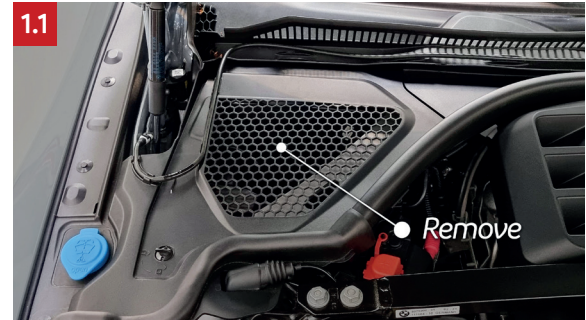

3**Installation****3.2 Remove strut braces.**

- Remove the bolts located in fig. 2. and remove the strut braces.

Tools: Use a 13mm socket for bolt 1, and a 15mm socket for nuts 2 to 9.

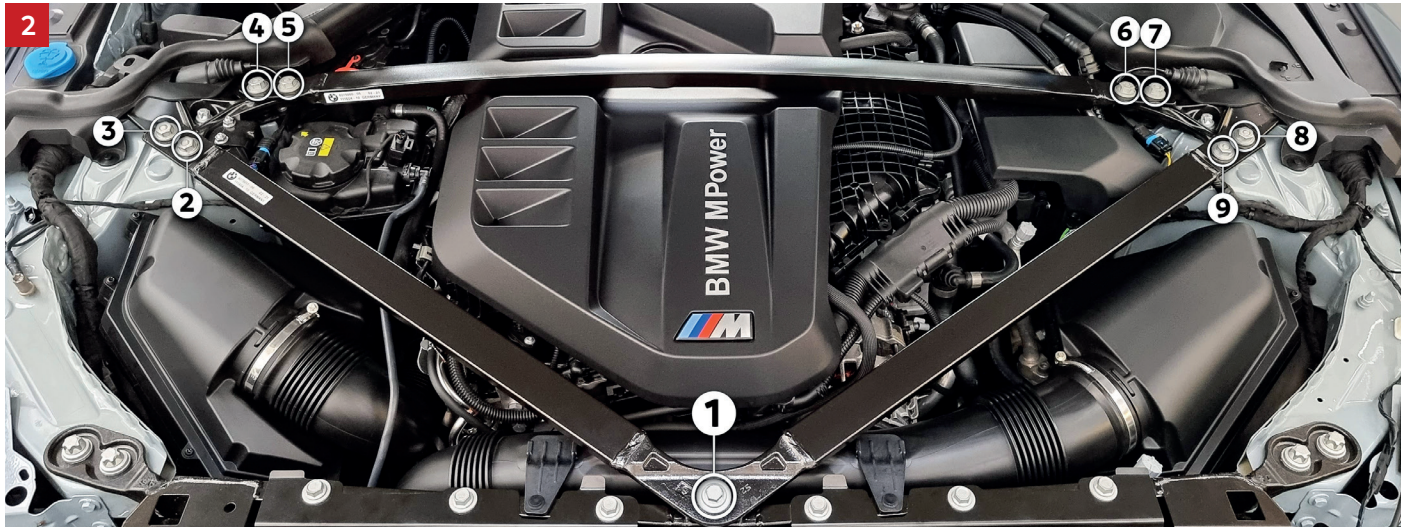

3

Installation

3.3 Remove the engine cover.

- Remove the engine cover by pulling it up (fig. 3).

No tools are needed for this action.

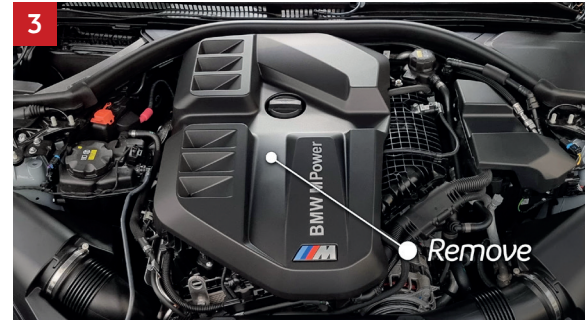

3.4 Remove the ECU cover.

- Remove the ECU cover by pulling it up (fig. 4).

No tools are needed for this action.

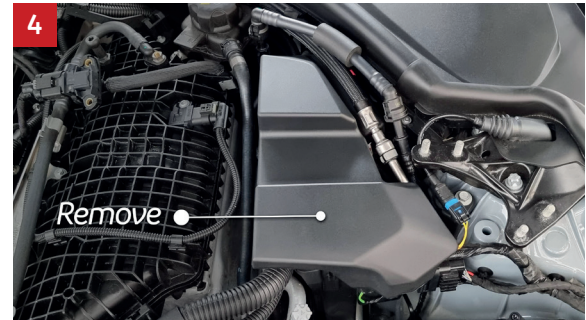

3

Installation

3.5.1 Remove the air intake.

- Remove the air intake (fig. 5.1). A detailed description of steps 1 to 3 is on the next page.

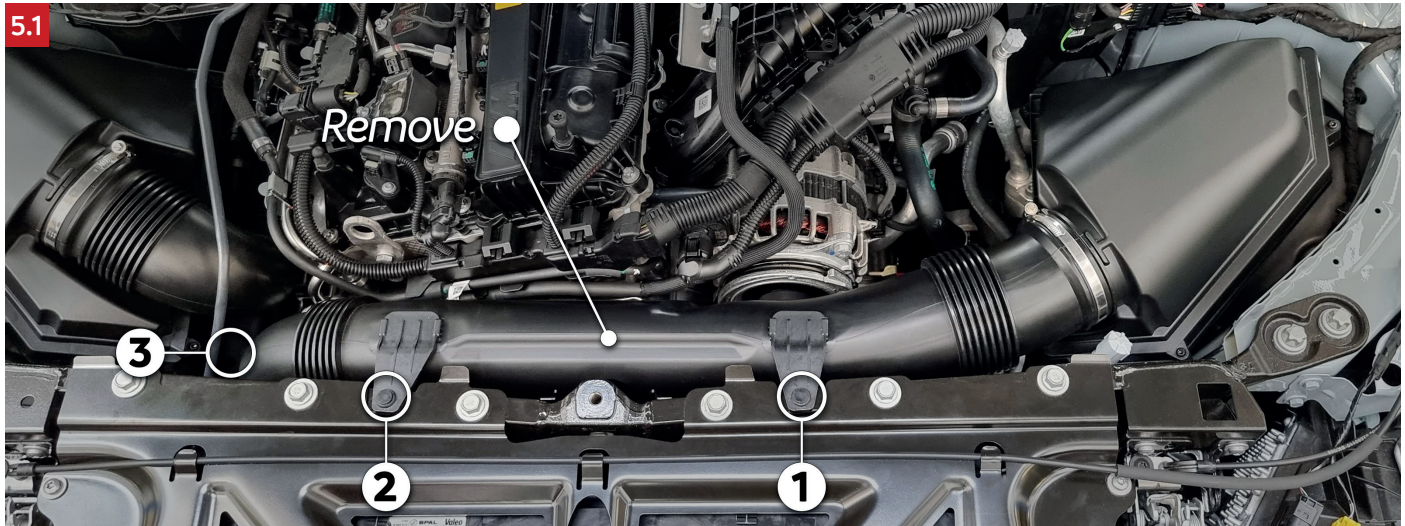

3

Installation

3.5.2 Remove the air intake.

- Remove plugs 1 and 2 (located in fig. 5.1).



3.5.3 Remove the air intake.

- Remove the clip (located in fig. 5.3) and remove the air intake from the engine bay.



3

Installation

3.6 Mount the iTronic.

- Connect part 1 of the iTronic mounting bracket to the car, using the rings and nuts provided in the box (fig 6.1 and 6.2).

Tools: Use a 10mm socket.

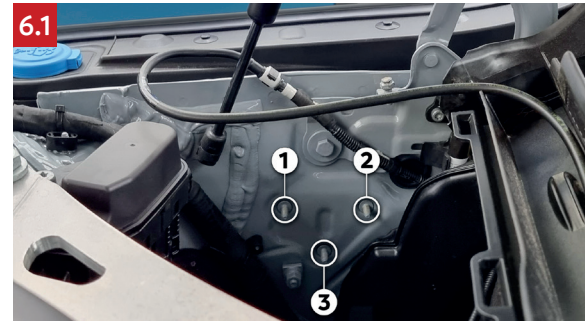
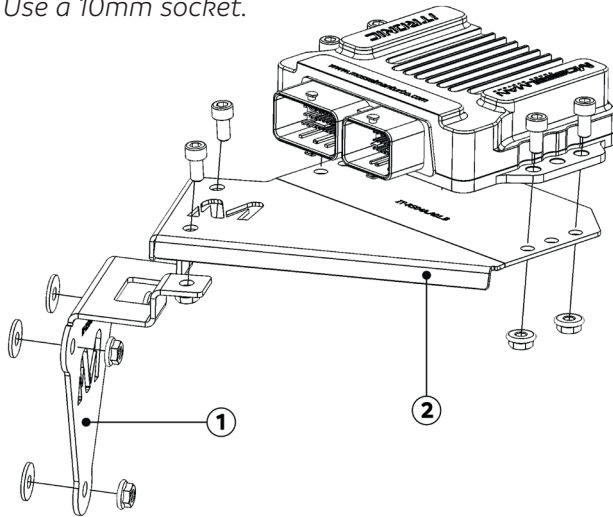

3**Installation****3.7 Mount the iTronic.**

- Place the iTronic on top of the mounting bracket (part 2), and fasten it with the bolts/nuts provided in the box.

Tools: Use a 5mm hex key.

- Connect part 2 of the mount with part 1, using the bolts provided in the box (fig. 7).

Tools: Use a 5mm hex key.

- Connect the iTronic wiring harness to the iTronic (fig. 7).

**3.8 Wiring harness.**

- Remove the plugs located in fig. 8, lift the rubber cover, and place the iTronic wiring harness underneath it.

- Reassemble the rubber cover.



3**Installation****3.9 Ground.**

- Remove the round nut of the ground point, using a Torx.
- Connect the black -wire from the iTronic wiring harness.
- Replace the round nut on the ground point.

Tools: Use a Torx 50.

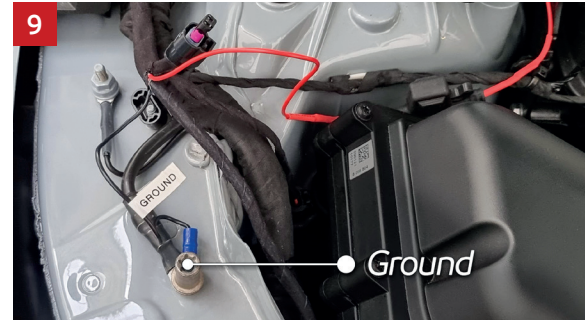
**3.10 Supply voltage.**

- Remove the round nut of the supply voltage, using a Torx.
- Connect the red +wire from the iTronic wiring harness.
- Replace the round nut on the supply voltage.

Tools: Use a Torx 50.



3**Installation****3.11 Rail pressure sensor.**

- Disconnect the connector from the rail pressure sensor.
- Attach the rail pressure sensor connector to the iTronic wiring harness.
- Connect the connector of the iTronic wiring harness to the rail pressure sensor.

**3.12 Manifold pressure sensor.**

- Disconnect the connector from the manifold pressure sensor.
- Attach the manifold pressure sensor connector to the iTronic wiring harness.
- Connect the connector of the iTronic wiring harness to the manifold pressure sensor.



3**Installation****3.13 Chargepipe pressure sensor.**

To access the chargepipe pressure sensor, the pump located in fig. 13.1 has to be moved aside.

- Remove the bolt located in fig. 13.2.

Tools: Use a 10mm socket.

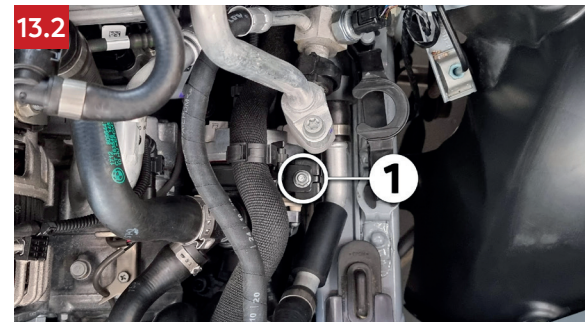
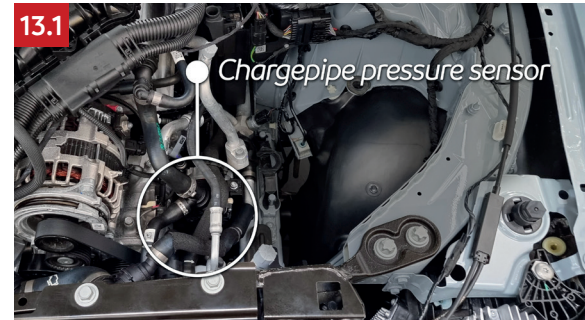

3**Installation****3.14 Chargepipe pressure sensor.**

Lift and move the pump away to make it easier to access the chargepipe pressure sensor (fig. 14).

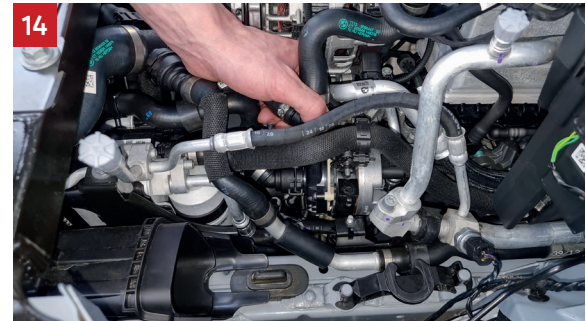
**3.15 Chargepipe pressure sensor.**

- Disconnect the connector from the chargepipe pressure sensor.
- Attach the chargepipe pressure sensor connector to the iTronic wiring harness.
- Connect the connector of the iTronic wiring harness to the chargepipe pressure sensor.
- Reinstall the pump.



3**Installation****3.16 CAN-bus connection - Wires.**

The necessary CAN wires are yellow/white (high) and yellow/black (low), and are located inside the wiring loom of the first CAN-bus connector. The wires are twisted in a pair.

The wires of the iTronic have the same colors, yellow/white (high) and yellow/black (low), and should be connected parallel on the existing CAN wires.

- Open the insulation of the wiring loom to reveal the CAN-wires. Connect the high and low wire from the CAN-bus to the iTronic wiring harness, using the red clips* provided in the box. (fig 16.2 and 16.3).

Use black tape to cover the clips after they are installed.

The yellow/white wire = high

The yellow/black wire = low

*

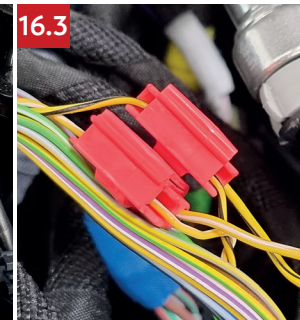
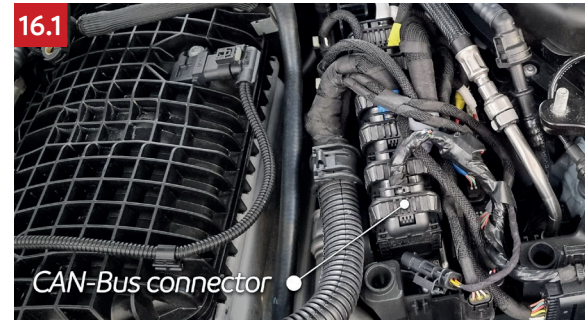

3**Installation****3.17 The iTronic is installed.**

- Turn on the ignition to check if the iTronic is properly installed. The Mosselman logo will burn when all sensors are connected the right way.

The iTronic logo will be blinking, this means that the iTronic is currently off. Turning the iTronic on/off will be described in chapter 4, page 20.

- Secure the iTronic wiring harness using the cable ties provided in the box. Make sure that it can't reach hot or moving parts.



3

Installation

3.18 Finish the installation.

- Reassemble the air intake, covers, and strut braces.

18



4***Using the iTronic***

The iTronic can be controlled, after installing it into the car, with the steering wheel buttons. This chapter will describe how to use the iTronic.



4**Using the iTronic****4.1 Turn the iTronic On/Off.**

Turn the iTronic On:

- Press and hold the BC button (fig. 1) for a couple of seconds. When the iTronic is turned on both LED lights on the iTronic module will be on (Mosselman logo and iTronic logo).

Turn the iTronic Off:

- Press and hold the BC button (fig. 1) for a couple of seconds. When the iTronic is turned off the LED light of the iTronic logo will be off on the iTronic module or will be blinking.



Mosselman Turbo Systems

📍 Molenstraat 4
6732 BP, Harskamp
The Netherlands

☎ +31 (0) 318 457832

✉ info@mosselmanturbo.com

🌐 www.mosselmanturbo.com



 /MosselmanTurboSystems

 @MosselmanTurbo

 /MosselmanTV